

Building a Smarter Systems Engineering Environment: IBM Research and Israel Aerospace Industries (IAI)

Eran Gery

DE, Rational Systems Platform

eran.gery@us.ibm.com

Alon Modai

Development & Systems Engineering

Processes, Corporate Operations, IAI

amodai@iai.co.il

Nir Mashkif

Research Staff Member, HRL

nirm@il.ibm.com

Innovate2010

The Rational Software Conference

Let's **build** a smarter planet.

The premiere software and product delivery event.
June 6–10 Orlando, Florida



ALM-1814C



Building a Smarter Systems Engineering Environment: IBM Research and Israel Aerospace Industries (IAI)

- Today's smart products require engineering processes to be carried over a complex development environment
 - Multi-discipline, Multi-application, Multi-role
- Key challenge: facilitate connectivity and traceability of **engineering data** across the lifecycle

Our solution approach:

- A Collaborative Lifecycle Management **Relationship Hub** (RH) among **all** engineering data and tools, enabling
 - Linking & Traceability
 - Impact analysis
 - Search & Query & Reporting
 - Common Baselining
- We will demonstrate how RH helps IAI's to meet those challenges enhancing their **existing** engineering environment



Agenda ●

The Systems Engineering Challenge

Systems Engineering in Israel Aerospace Industries (IAI)

IBM Research and IAI project collaboration: PLM Relationship Hub (RH)

Demonstration

Summary



Challenges in Complex Products Development

Collaboration between domains is still manual.

- ✓ Related and dependent data
- ✓ Progress on related tasks (process visibility)
- ✓ Progress related to the overall program plan
- ✓ Visibility to changes in related system elements

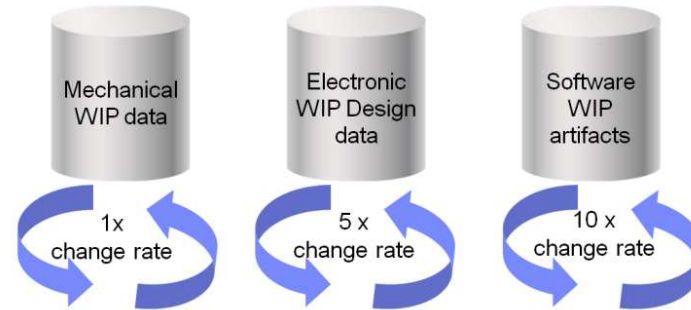

Many Different Roles



System Engineer



Hardware Engineer

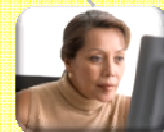

Mechanical Engineer



Software Engineer



Test Engineer

Best of Breed Applications, Domain Specific Processes

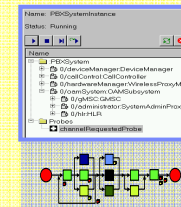
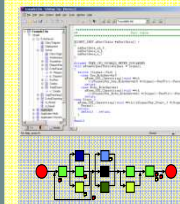
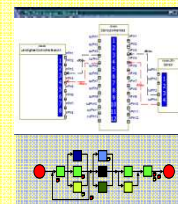
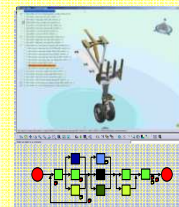
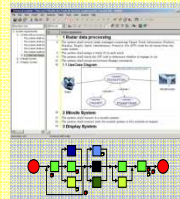

Domain Specific Program Assets



Program Master Plan

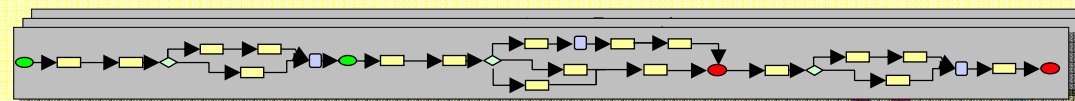

Business results of increased product complexity driving critical imperatives for product development and delivery



Business View

Product missed customer needs	46%
Late to market/missed demand	33%
Poor commercialization / promotion	26%
Product quality	24%
Pricing	23%
No clear product differentiation	19%

The CIO's Guide to the PERFECT Launch: Translating Innovation to Business Benefit, AMR Research, 2005



Engineering Opportunity

Improve communication and collaboration across disciplines	71%
Increase visibility into status of requirements	49%
Increase ability to predict system behavior prior to testing	46%
Implement or alter new product development processes for a multi-disciplinary approach	43%
Increase real time visibility of product Bill of Materials (BOM) throughout the development process	39%

Aberdeen Group, System Design: New Product Development for Mechatronics, Michelle Boucher, David Houlihan, January, 2008

Enterprise Integrated Systems Development

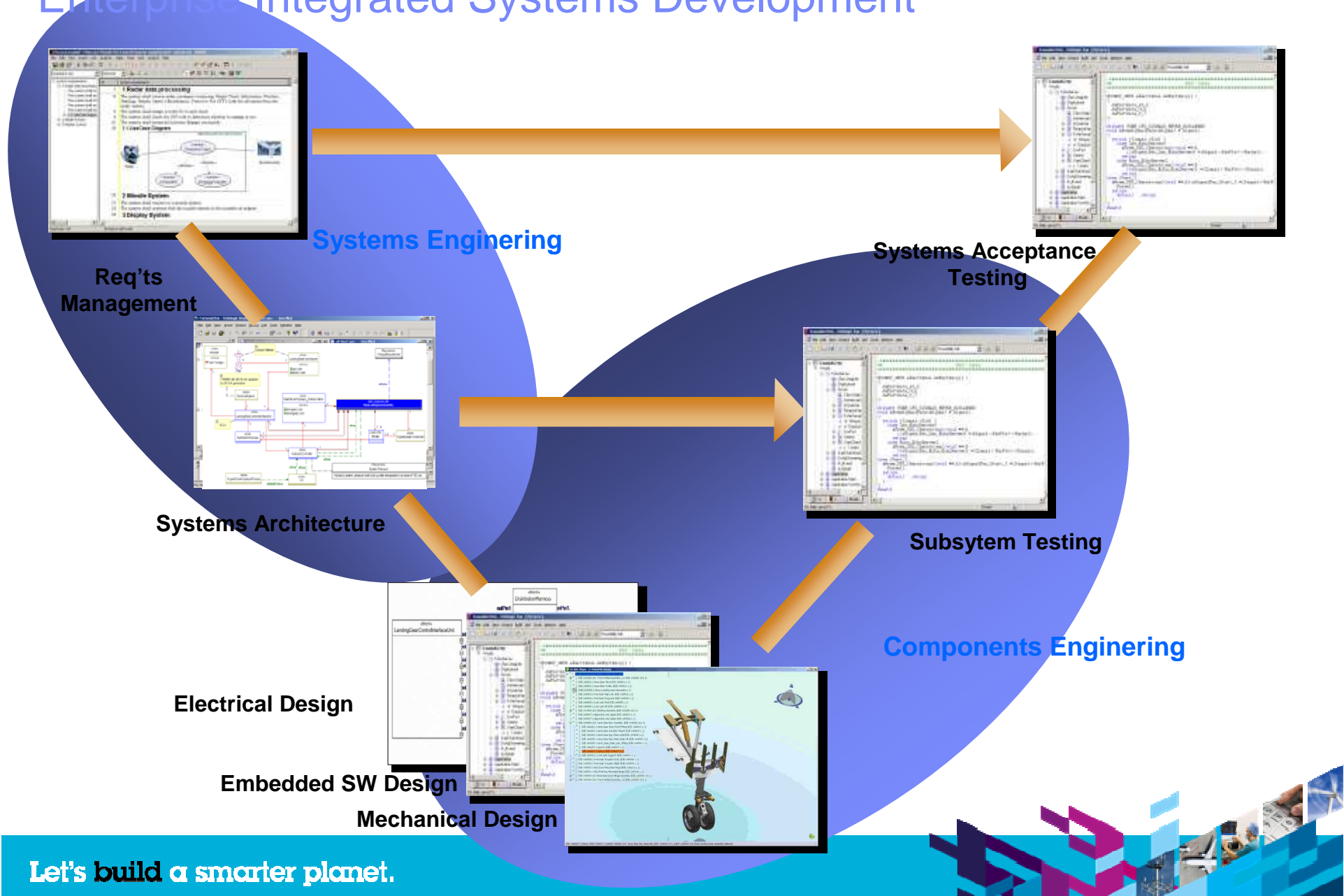

IBM Product Development Integration Framework (PDIF): An umbrella for multi-disciplinary CLM integration

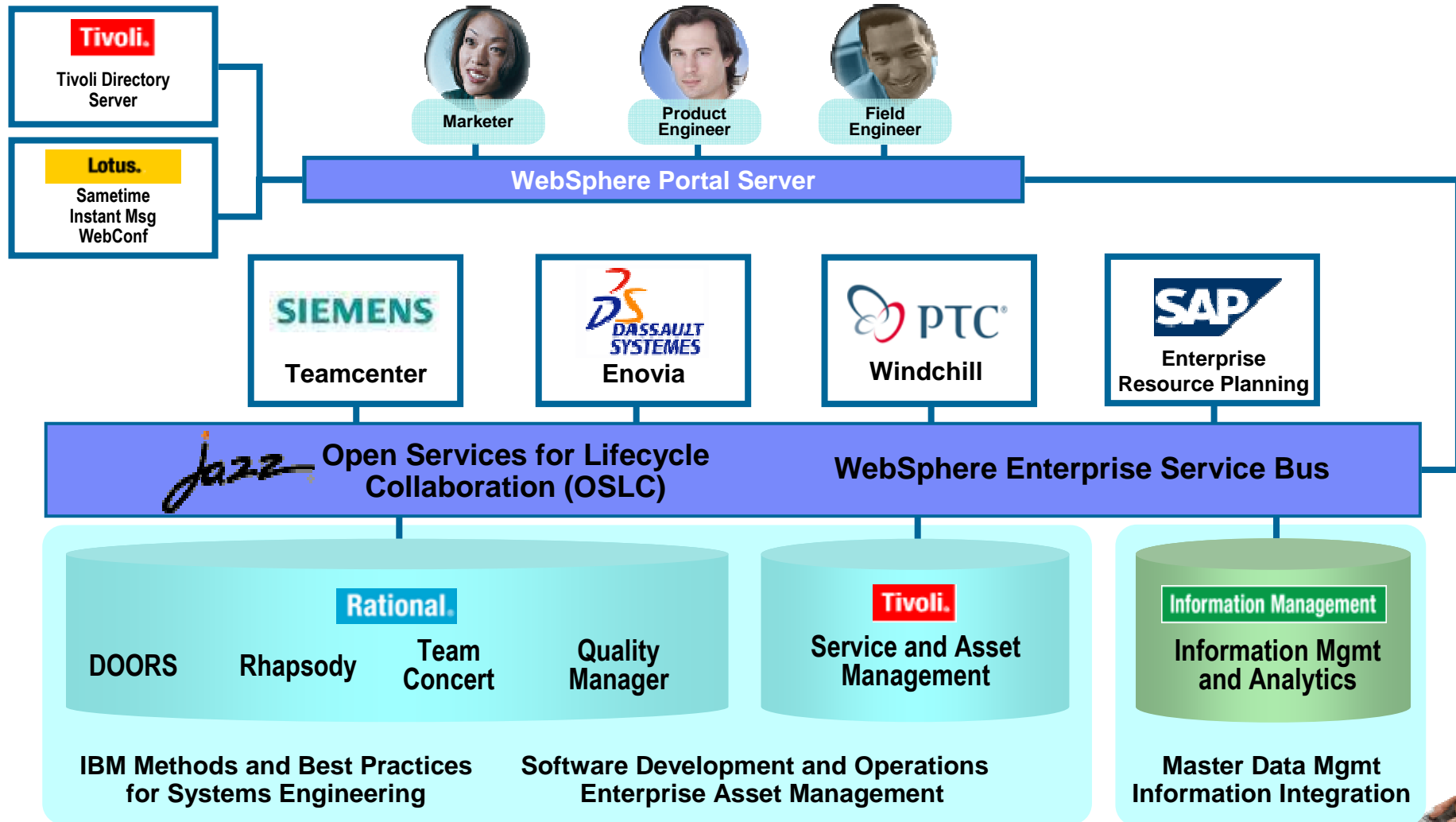

Jazz: Leveraging Web technology for CLM

The Web has proven to be the most **scalable**, **open**, and **flexible** integration technology!

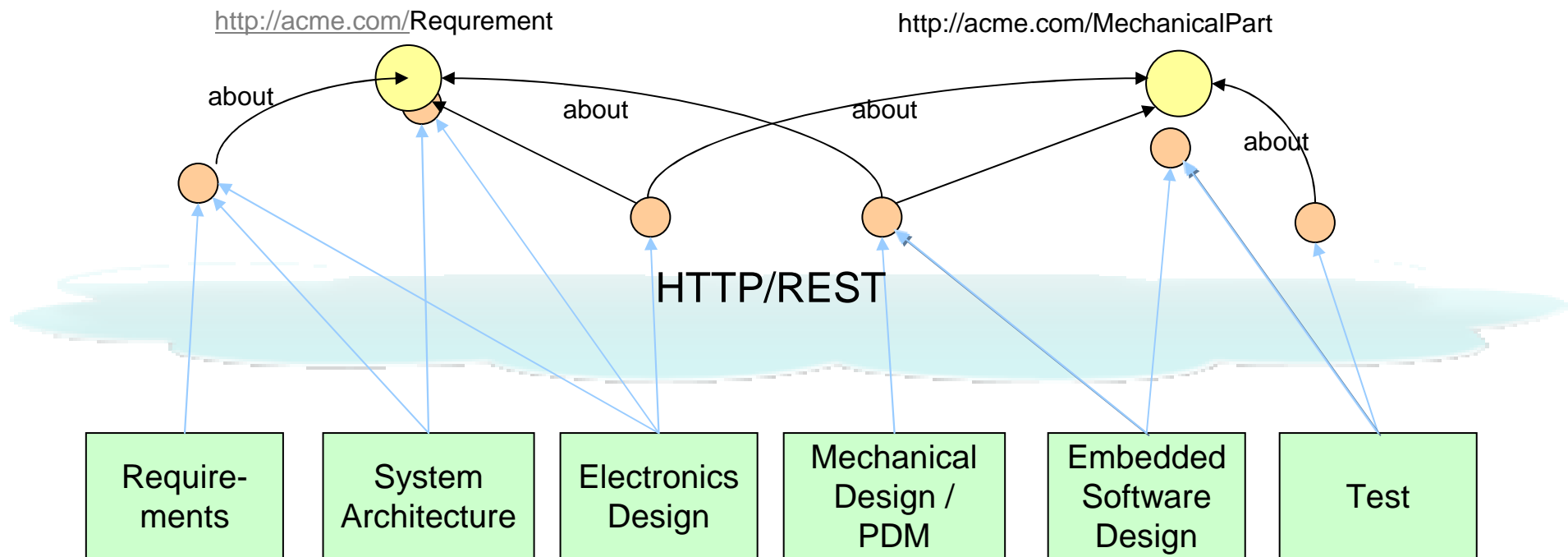

Jazz provides the infrastructure to meet RH challenges!



Jazz: IBM Rational Architecture for Application Integration

- Jazz tools implement the Open Services for Life-cycle Collaboration (OSLC) specifications
- Jazz Integration Architecture (JIA) extends OSLC to integrate tools further
 - ▶ JIA defines Jazz Foundation Services
 - Storage, administration, composite user interface, query, ...
- Existing applications can plug into the JIA incrementally
- Jazz Foundation Server – an implementation of Jazz Foundation Services

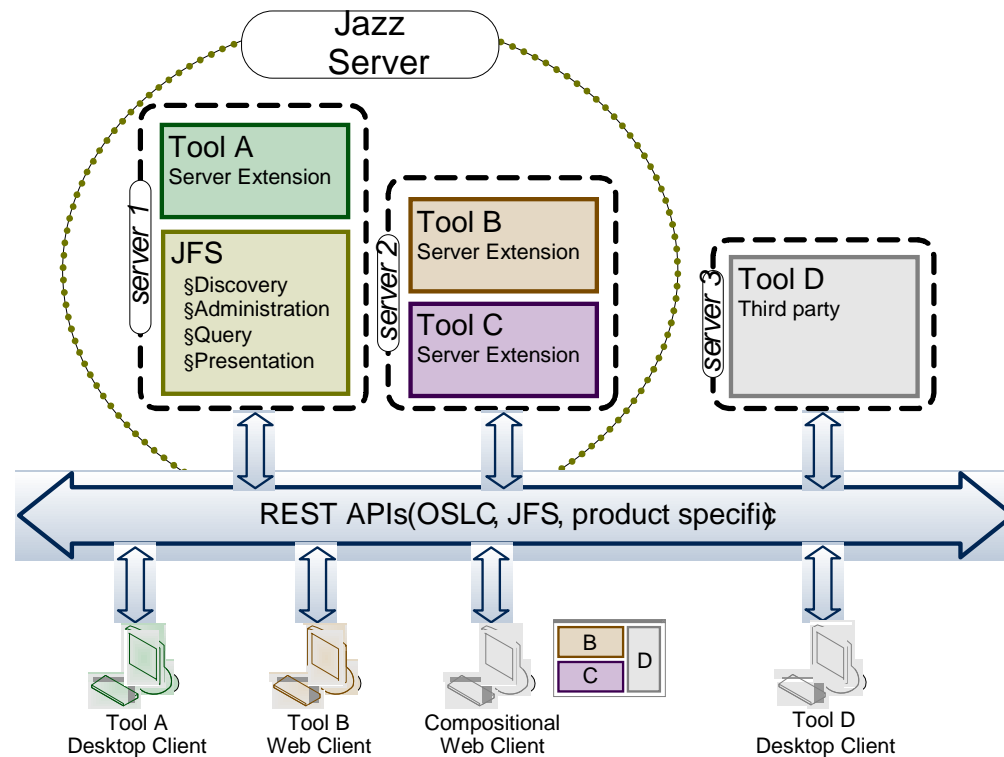

Jazz provides the infrastructure to meet RH challenges!

Agenda ●

Systems Engineering in IBM

Systems Engineering in Israel Aerospace Industries (IAI)

IBM Research and IAI project collaboration: PLM Relationship Hub (RH)

Demonstration

Summary



Welcome to Israel Aerospace Industries (IAI)



Let's build a smarter planet.



IAI at a Glance



- Global Company:
 - Over 30 subsidiaries worldwide, including holding and marketing companies
 - Active on land, at sea, in the air and in space
- Current workforce: 16,700
- 6 groups & 21 divisions in Israel
- Sales: \$3.6B
 - Over 80% export
 - Backlog :\$8B+



 Marketing Offices / Holding Companies
 Active Companies



Comprehensive Technology Base



- **IAI Excels in Complex “Systems of Systems” (SoS)**
- **IAI Comprehensive Technology Base is key to SoS development**
- Aircraft Design and Development
- Intelligence Systems:
Satellites, ELINT, COMINT, SAR
- Sensors and Seekers:
Radar, SAR, Electro-optical Payloads, Inertial, Sigint units for Aircraft, Ships, UAVs
- ATBM/C³I, NCO/NCW:
Anti-Ballistic Missiles; Command, Control, Computing and Interoperability; Net-Centric Operations Warfare
- Missiles:
Satellite Launch Vehicles, Air & Missiles Defense System, Precision-Strike Systems Guided by Radar, Laser, Optics and Inertial Sensors
- Composite Aero-structures
- Unmanned Systems:
Air, Ground and Maritime Vehicles, Robotics
- Space Systems:
LEO Lightweight Imaging and SAR Satellites, GEO Communication Satellites



IAI Annual R&D Exceeds \$700M



IAI System Development Challenges : The Business View

- Time to market and innovative products:
 - ▶ Agile multi-disciplinary development processes to integrate new products from existing components and provide previously unavailable capabilities
 - ▶ Systematic reuse of systems, components, and work products
 - ▶ Product line oriented development
- Effective methodologies to develop System of Systems
- Integrated development environments allowing large scale development by distributed teams



Hierarchical Application of New Product Introduction (NPI)

System Level

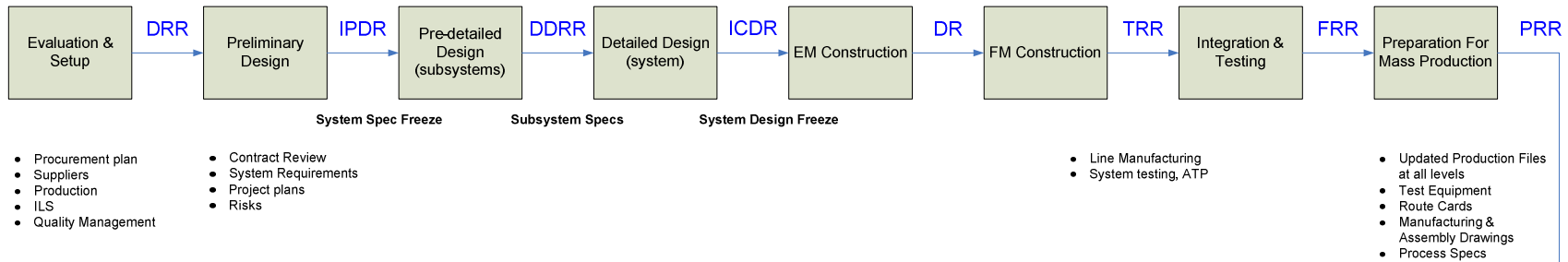

Subsystem/Component Level

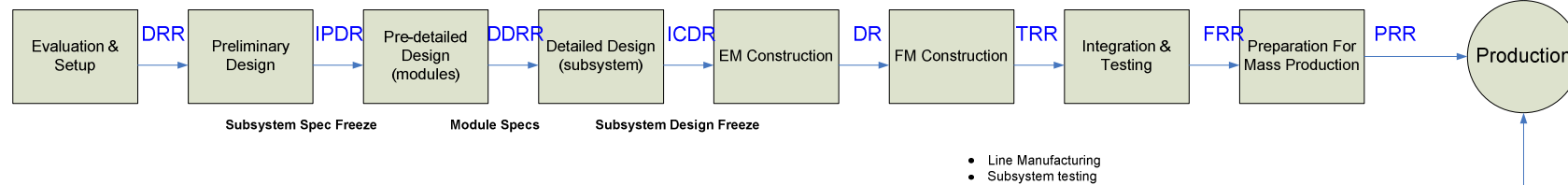

Module Level

(HW - LRUSW - CSC)

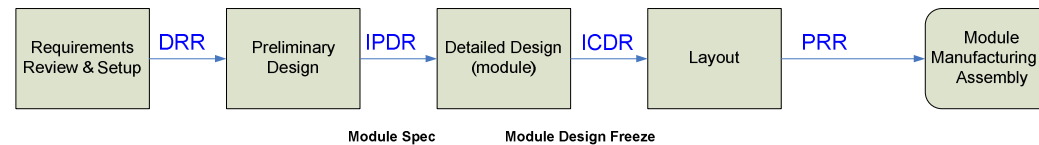

IAI's Environment

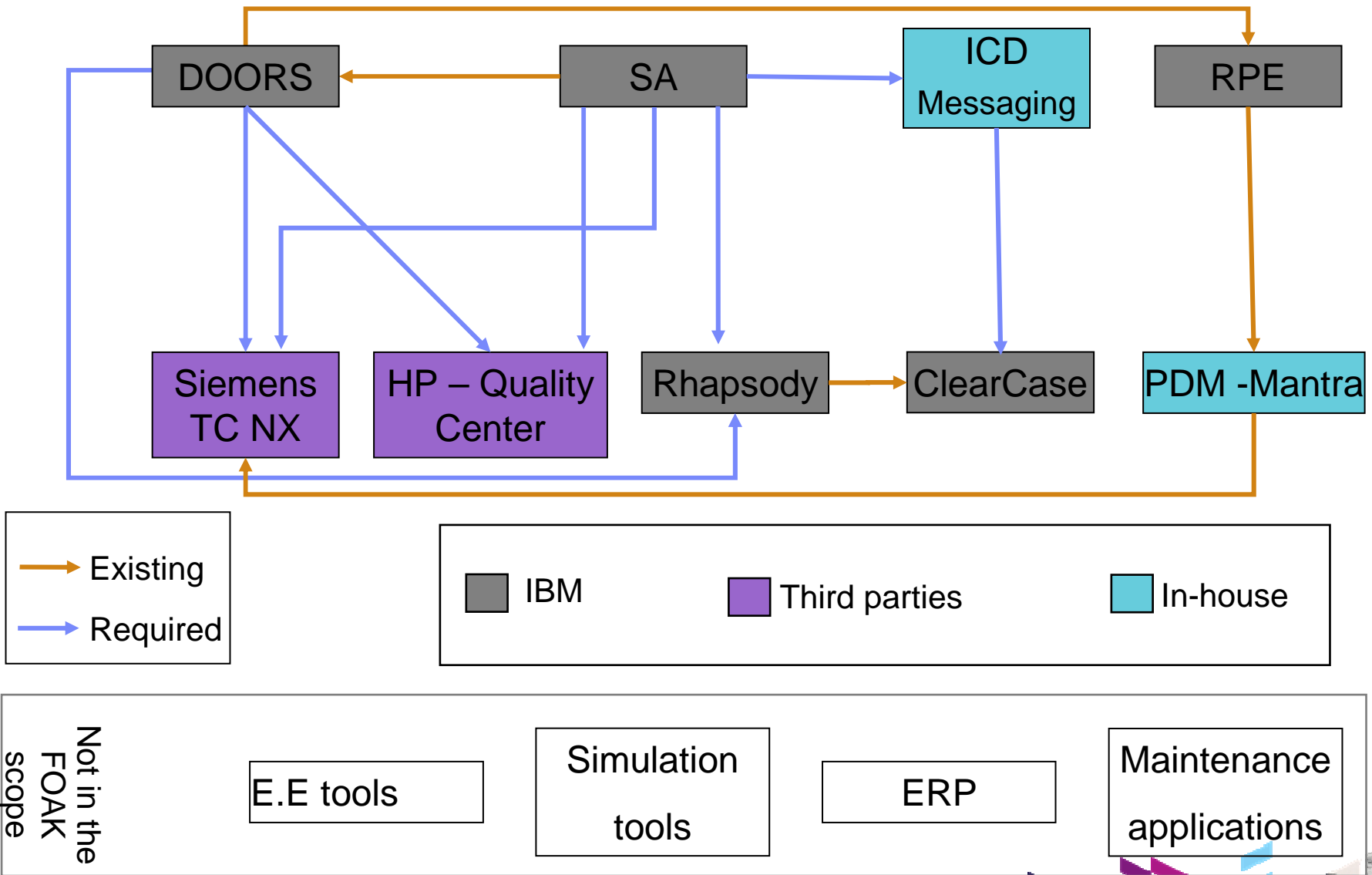

Example: Requirements Engineering – Inter-Relationships

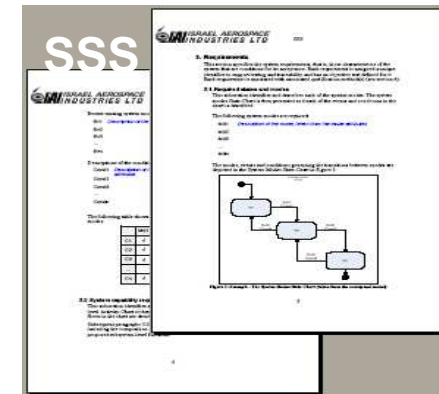
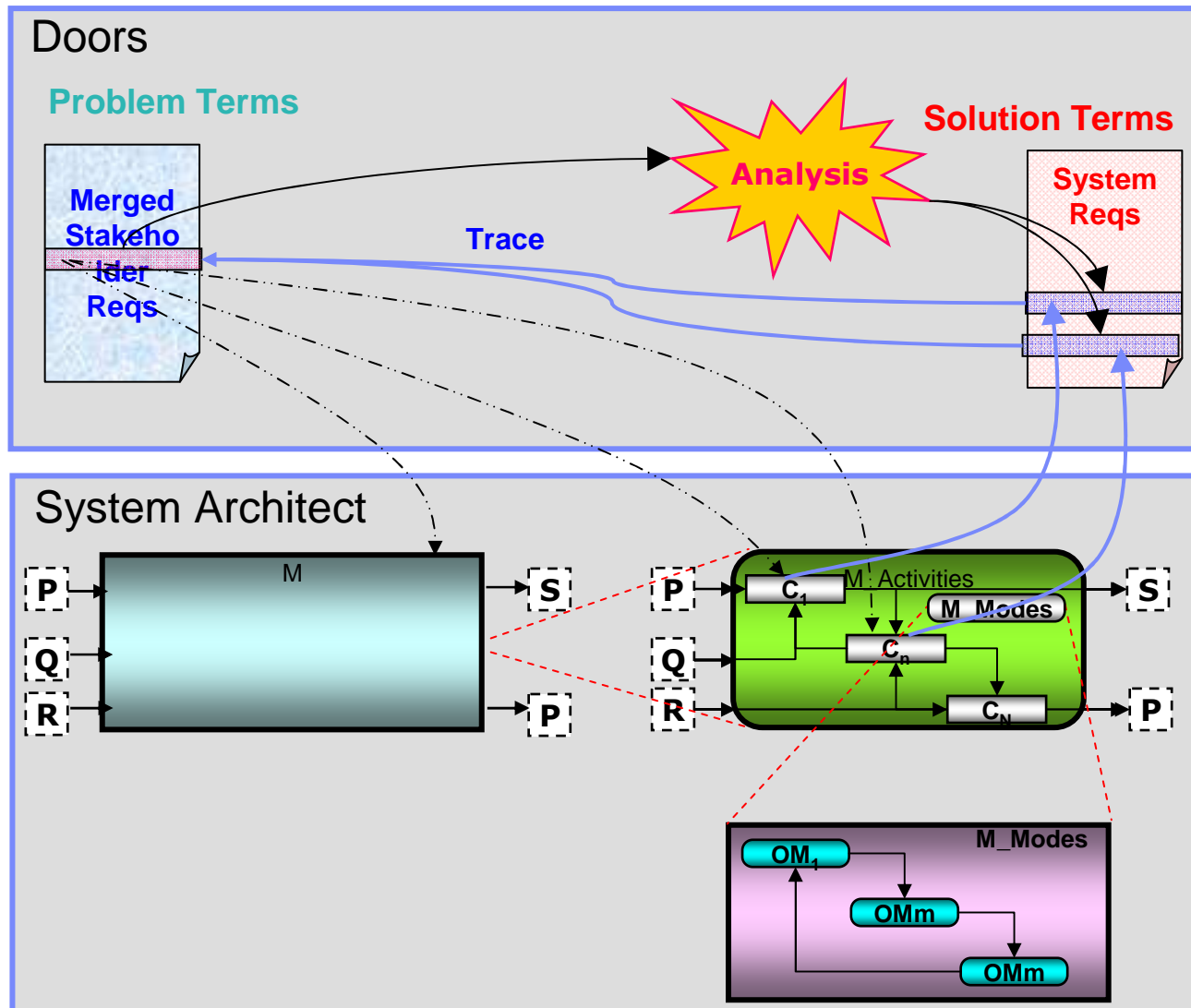

Challenges:

- Associate requirements in DOORS with model elements in SA **without** having to copy model elements from SA into DOORS
- Generate an SSS, using RPE, based on information from DOORS & SA, and inter Relations, **without** having to copy model elements and diagrams from SA into DOORS



Case Study: SARAH (Search and Rescue Automated Helicopter)

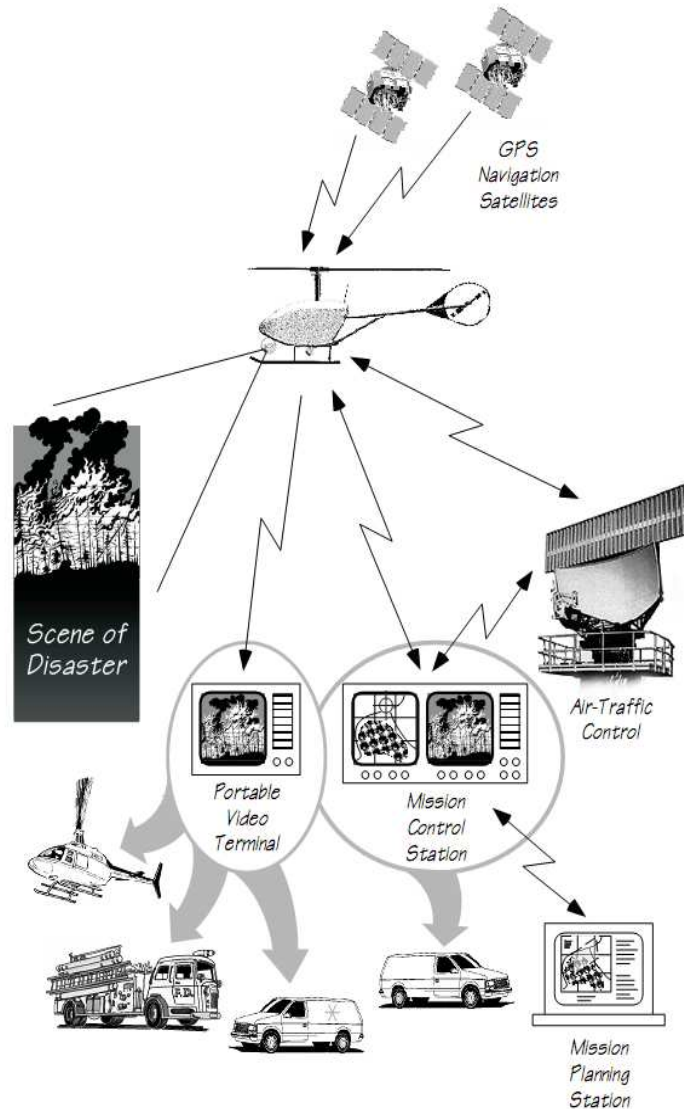

Mission:

- Provide search & rescue forces with real-time visual imagery from a given disaster area, via an unmanned platform

Main characteristics:

- Unmanned helicopter intended to operate:
 - ▶ Over populated areas
 - ▶ In civilian airspace
 - ▶ Over open areas
- Day & night visual means:
 - ▶ Visible light video (day)
 - ▶ “Starlight”
- Emergency landing:
 - ▶ With no risk to life or property on ground
 - ▶ Minimizing damage to air vehicle
- System configuration:
 - ▶ Hand-held small mobile video terminals
 - ▶ Air platform
 - ▶ Mission planning and control stations



Agenda ●

Systems Engineering in IBM

Systems Engineering in Israel Aerospace Industries (IAI)

IBM Research and IAI project collaboration: PLM Relationship Hub (RH)

Demonstration

Summary

The PLM Challenges Addressed by the FOAK Project

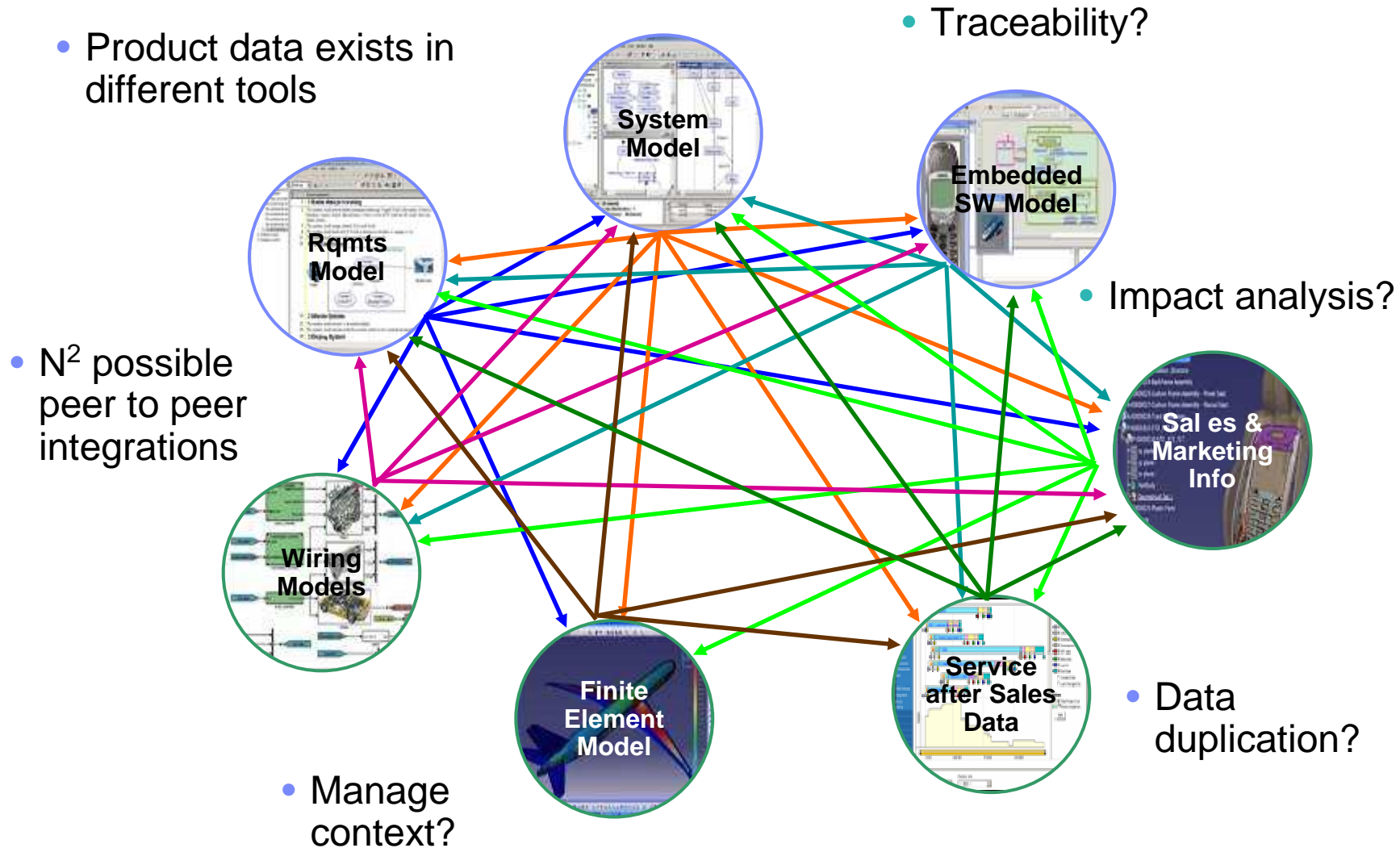

The PLM Challenges – The Solution Approach

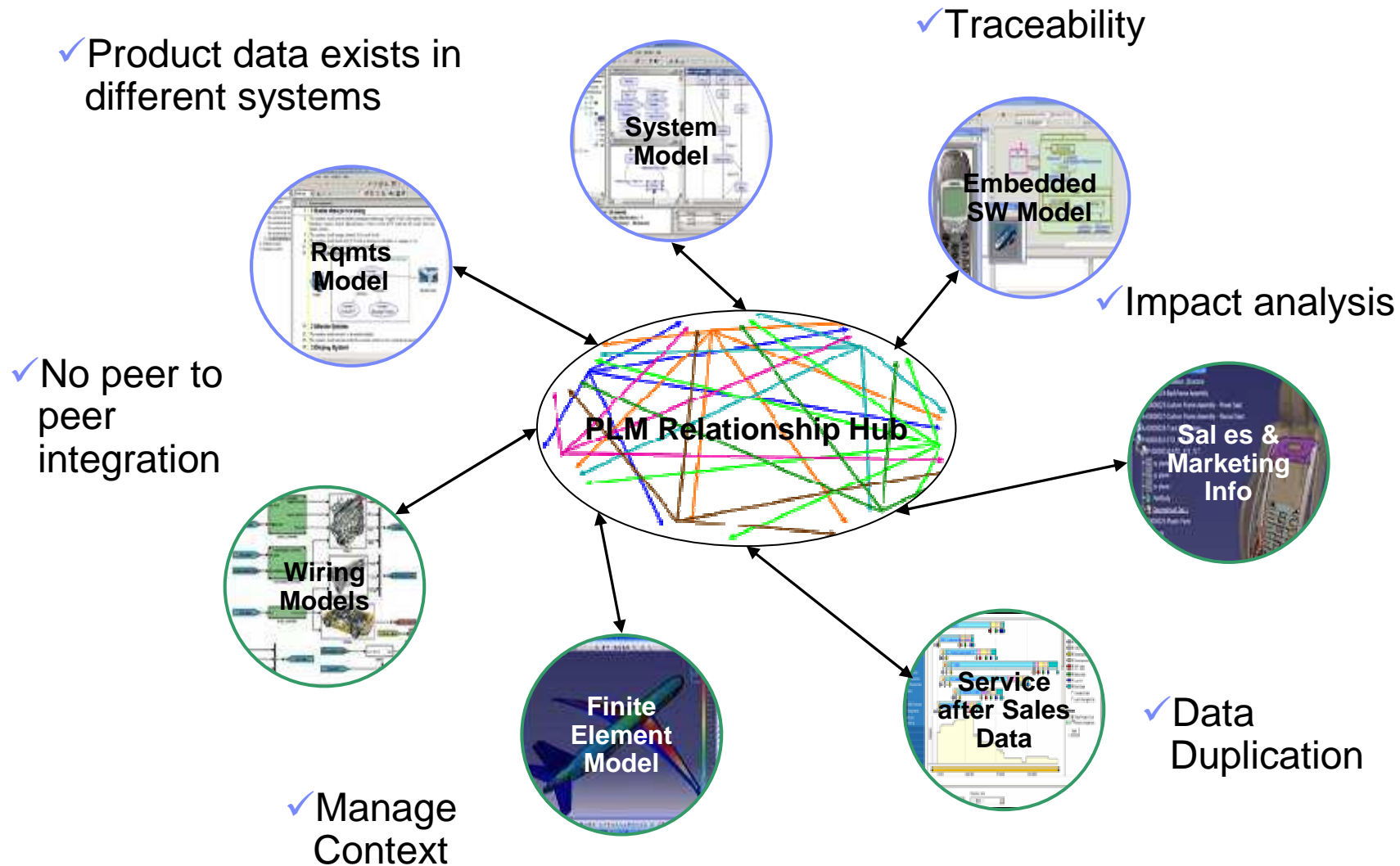

PLM Relationship Hub Project Objectives

- Create a “virtual” PLM system from a cross discipline tools
 - ▶ As opposed to migrating all data to a single “**all-in-one**” PLM application
 - ▶ The core capability is to manage a large network of relationships among distributed design artifacts
- Extend IBM’s PDIF to include multi-domain linking
- Integrate with the customer’s existing PLM toolset in a non-intrusive manner
- Leverage Jazz and infrastructure being developed for Rational tooling
- Explore the best methods for capturing and representing cross-discipline relationships and how these can be accessed and used by various engineering roles.



Capabilities of the PLM Relationship Hub

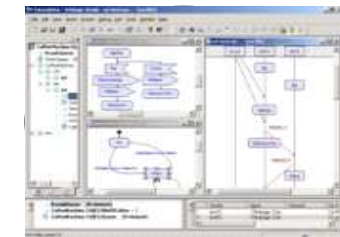

SA



DOORS

Relationship Hub:

- Cross tool models/artifacts integrated view
- Cross tool models/artifacts bidirectional relations
- Cross tool search and query
- Impact analysis
- Connectivity rules checking via constraint satisfaction technology
- Cross tool reports and documents generation
- Cross domain baselining

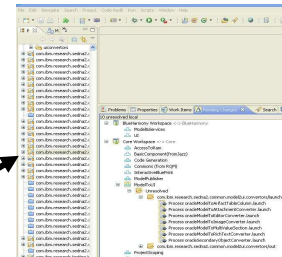

Clearcase /RTC

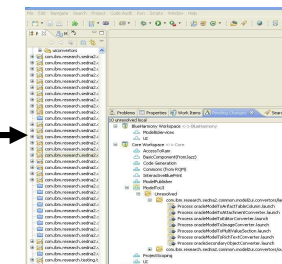

Rhapsody

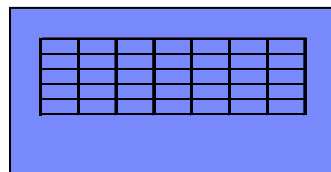

Wiring/
messaging

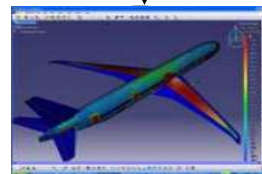

TC/NX

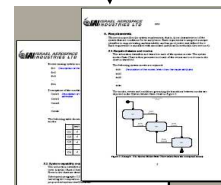

Reports/ RPE



PDM

TC/Mantra



Cross Tool Models/Artifacts Integrated View

Relationship Hub

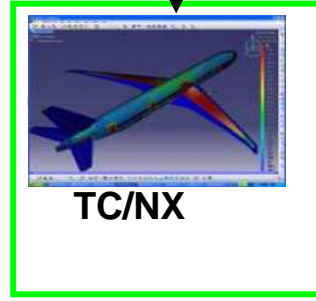
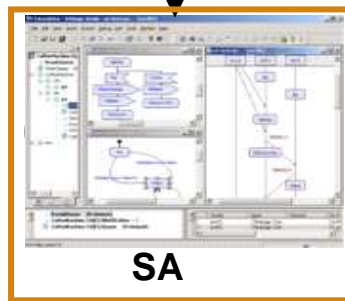
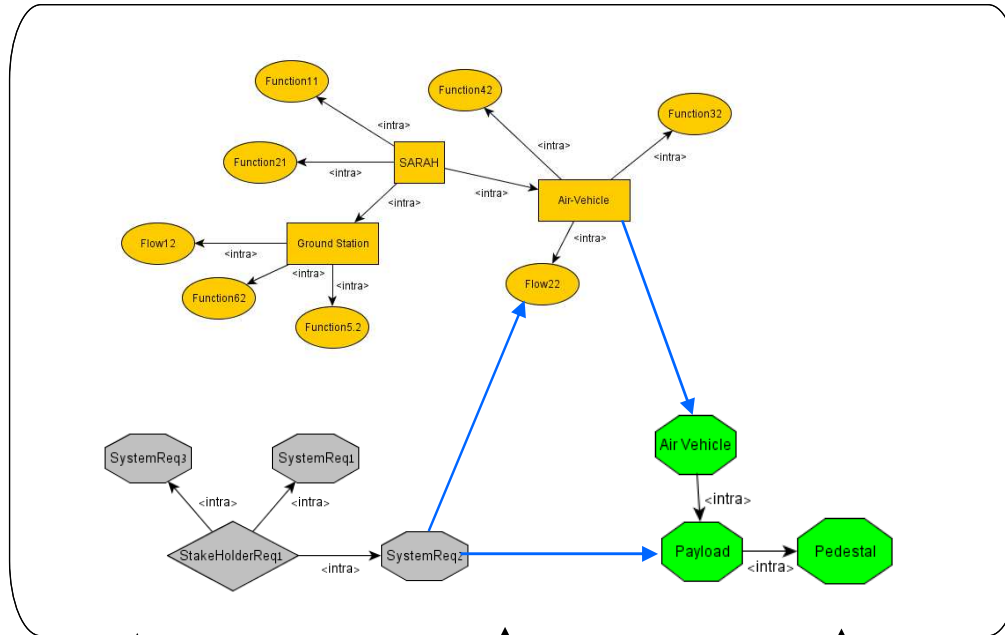

- Integrated view of data models from heterogeneous engineering tools
- Cross tool relations among model elements from different tools/disciplines
- Stores only indexing data including intra-relationships
- Common Web UI for creating Inter Relations
- Scopes the target element according to requested context



Impact Analysis

Relationship Hub

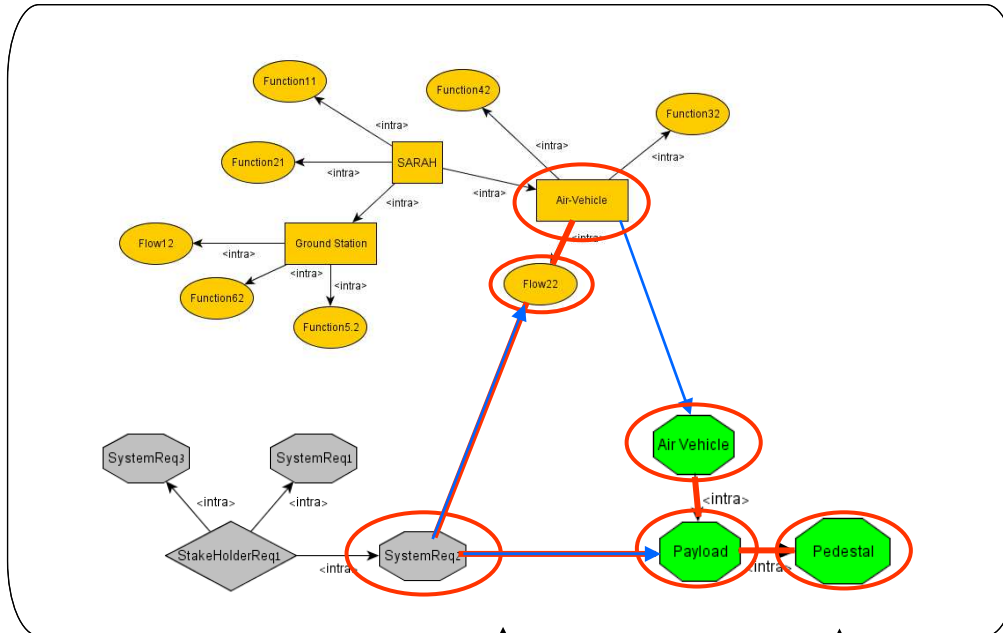

- Possibility of tracing and tracking potential impact on model elements as a result of a change in one model element
 - Upstream impact analysis
 - Downstream impact analysis
 - Distance
- Uses advance visualization
- Reduces irrelevant elements in the impact graph
- Focuses on cross displease Impacted Elements

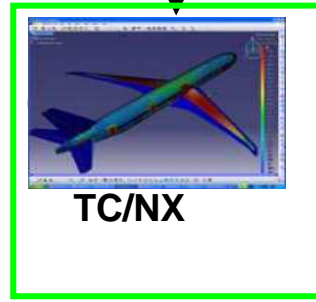
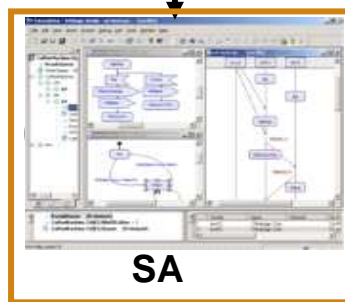

Connectivity Rules Checking

- Enforces IAI's connectivity methodology by checking set of connectivity rules
- RH use cases

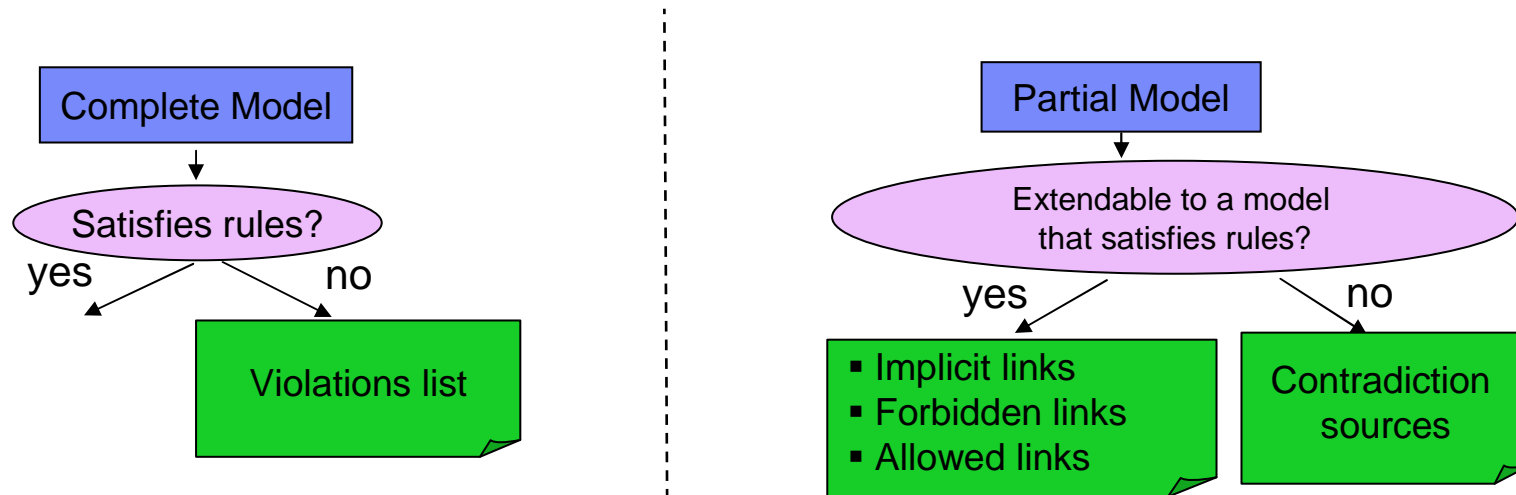

- Rules arising from process methodology
 - ▶ System requirement must be linked to a single model element in SA or is defined non-functional
 - ▶ Siblings elements in SA model should not be mapped into Doors parent and child elements
 - ▶ If a test is linked to a function in SA and to a requirement, the function and the requirement should also be linked
- Uses IBM constraint solver (CSP)
 - ▶ Solves NP-complete problems (partial links)
 - ▶ Constraints language (declarative, not procedural)



Connectivity Rules Checking – Example

Relationship Hub

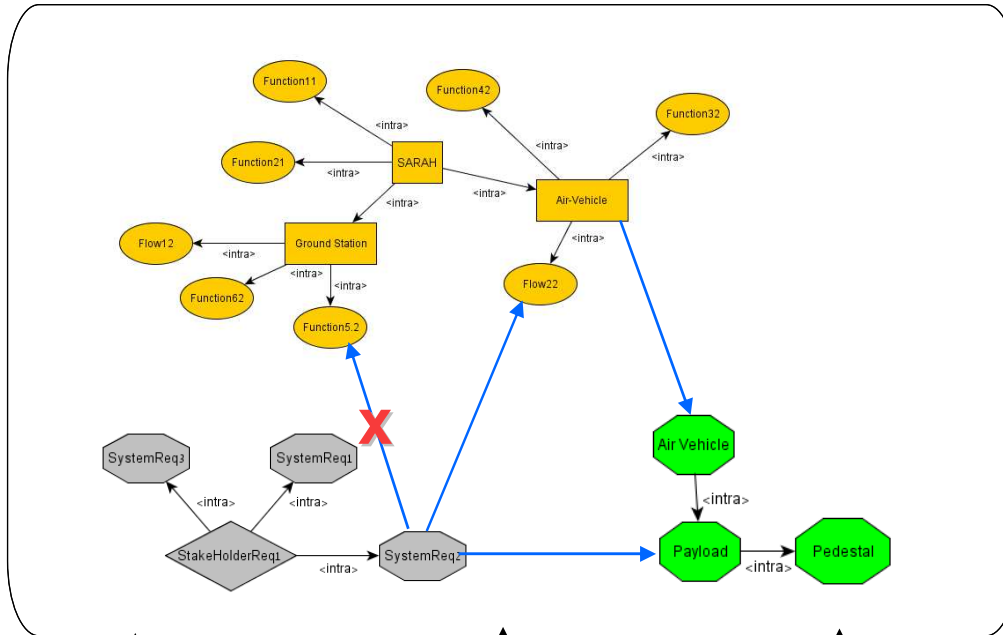

1. Add a relation between System Req2 and function 6.2
2. Execute Connectivity Rules Checking
3. This relation is recognized as **non-valid** (since SystemReq2 can only be associated to model elements of sub-system Air-Vehicle)

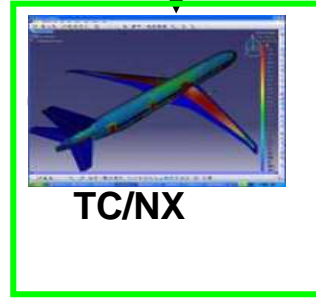
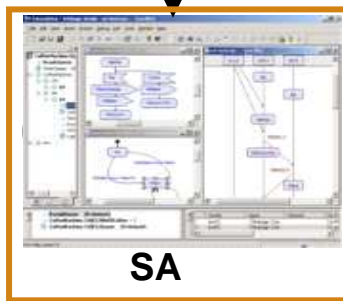

Cross Tool Documents Generation Using RPE

Generates an SSS [System Specification] with the new integration architecture

DOORS

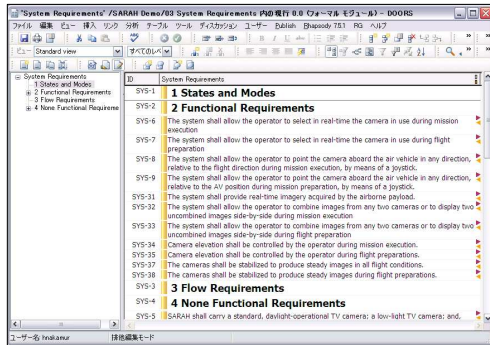

Relationship Hub

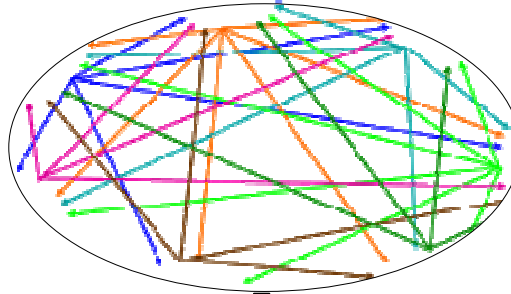

System Architect

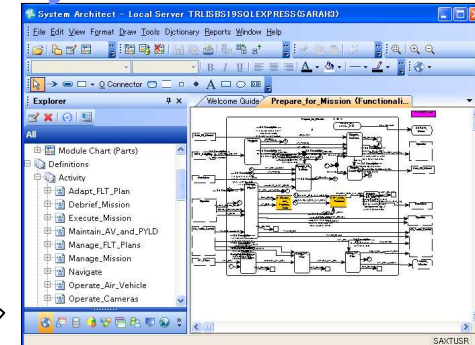

DOORS DXL

REST API

REST API

Modified SSS Template

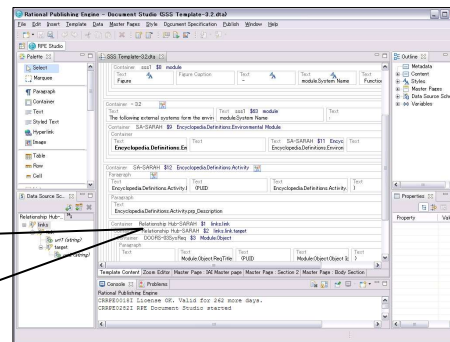
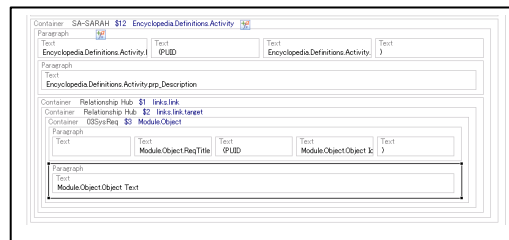

RPE

Generated SSS

SA Diagram

DOORS Requirement

Figure 1 - SARAH Functionality

The following external systems form the environment of SARAH:

- Air_Traffic_Control**
Air traffic control in charge of the airspace used
- Area_Of_Interest**
The area covered by the SARAH payload field-of-view
- Environment**
The physical environment in which SARAH operates
- GPS_Satellites**
Global Positioning System (GPS) satellites coastal
- Maintainer**
Systems maintainer (may be the same person as "Operator")
- Observer**
Any person exploiting SARAH imagery
- Operator**
The system operator
- Other Air Vehicles**

SA Definition

Generates

IAI's "TO BE" Environment

IAI tools/systems relationships

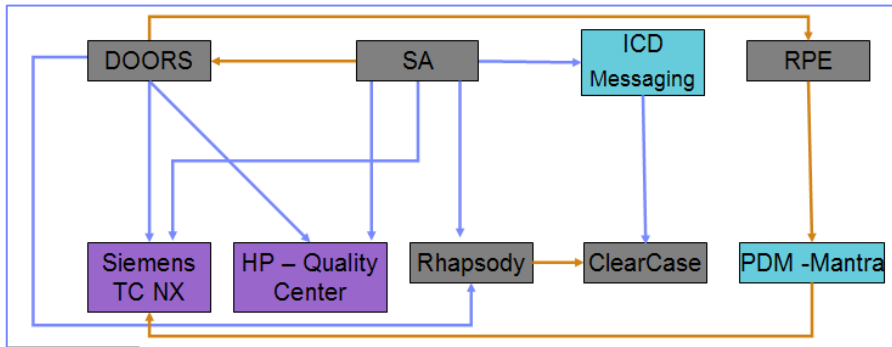

IAI tools/systems relationships with PLM Relationship Hub

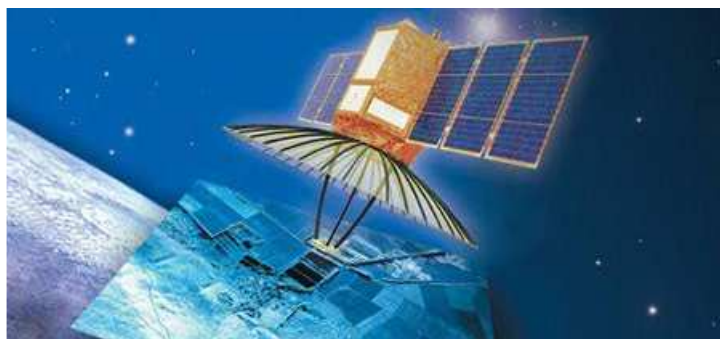
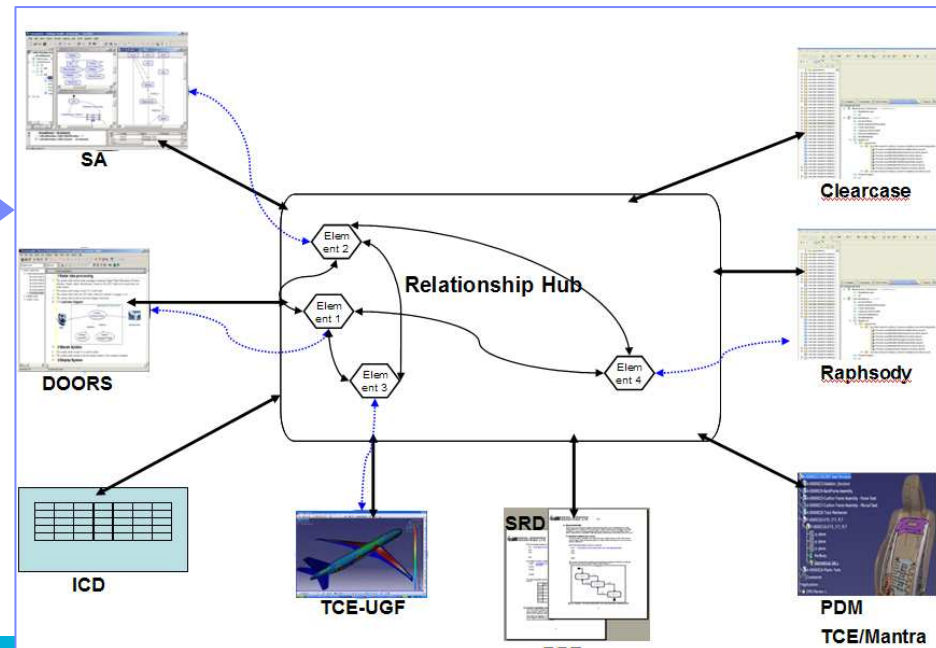
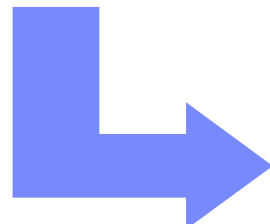

Let's build a smarter planet.

PLM Relationship Hub Conceptual Architecture

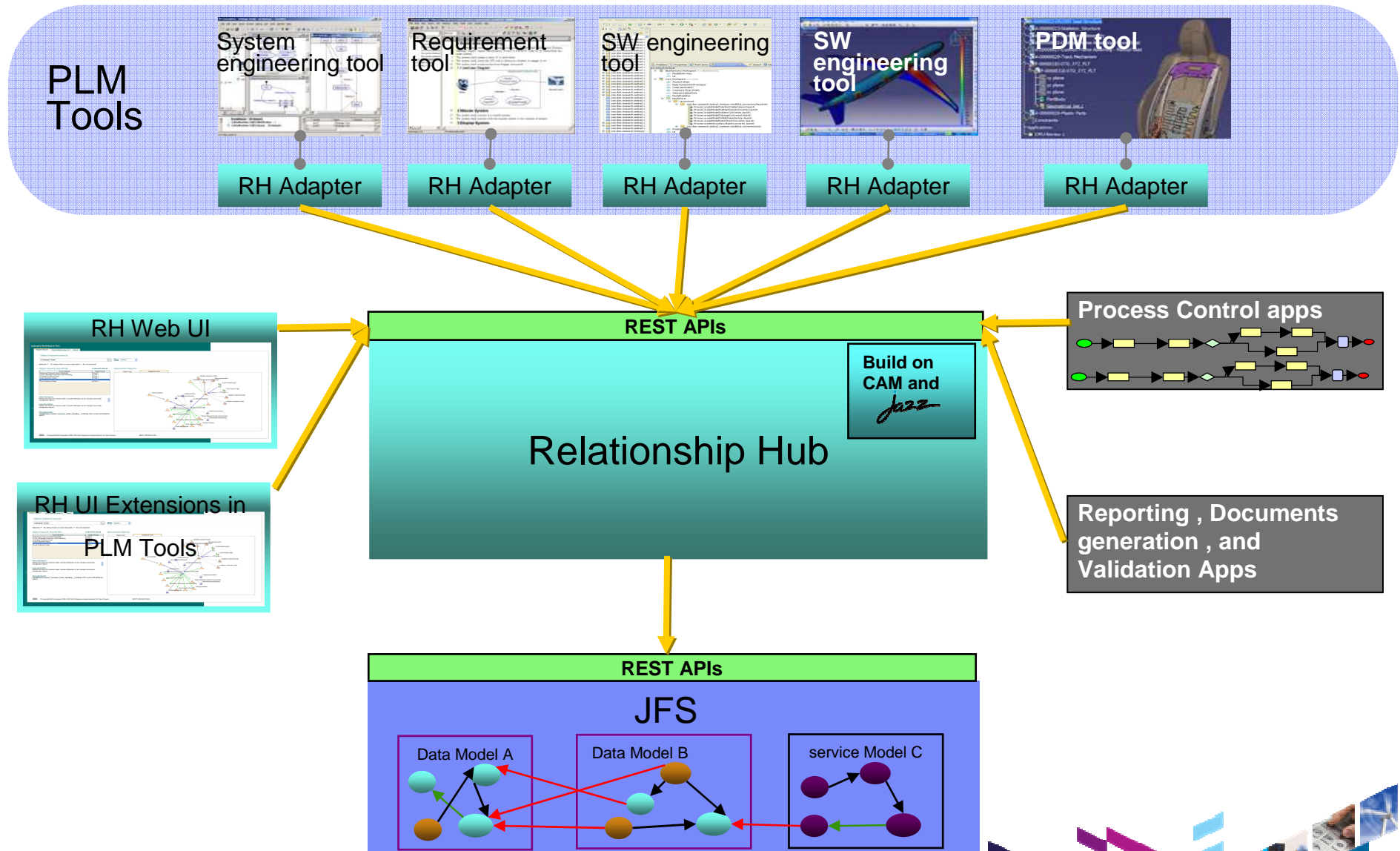

The PLM Relationship Hub Component Environment

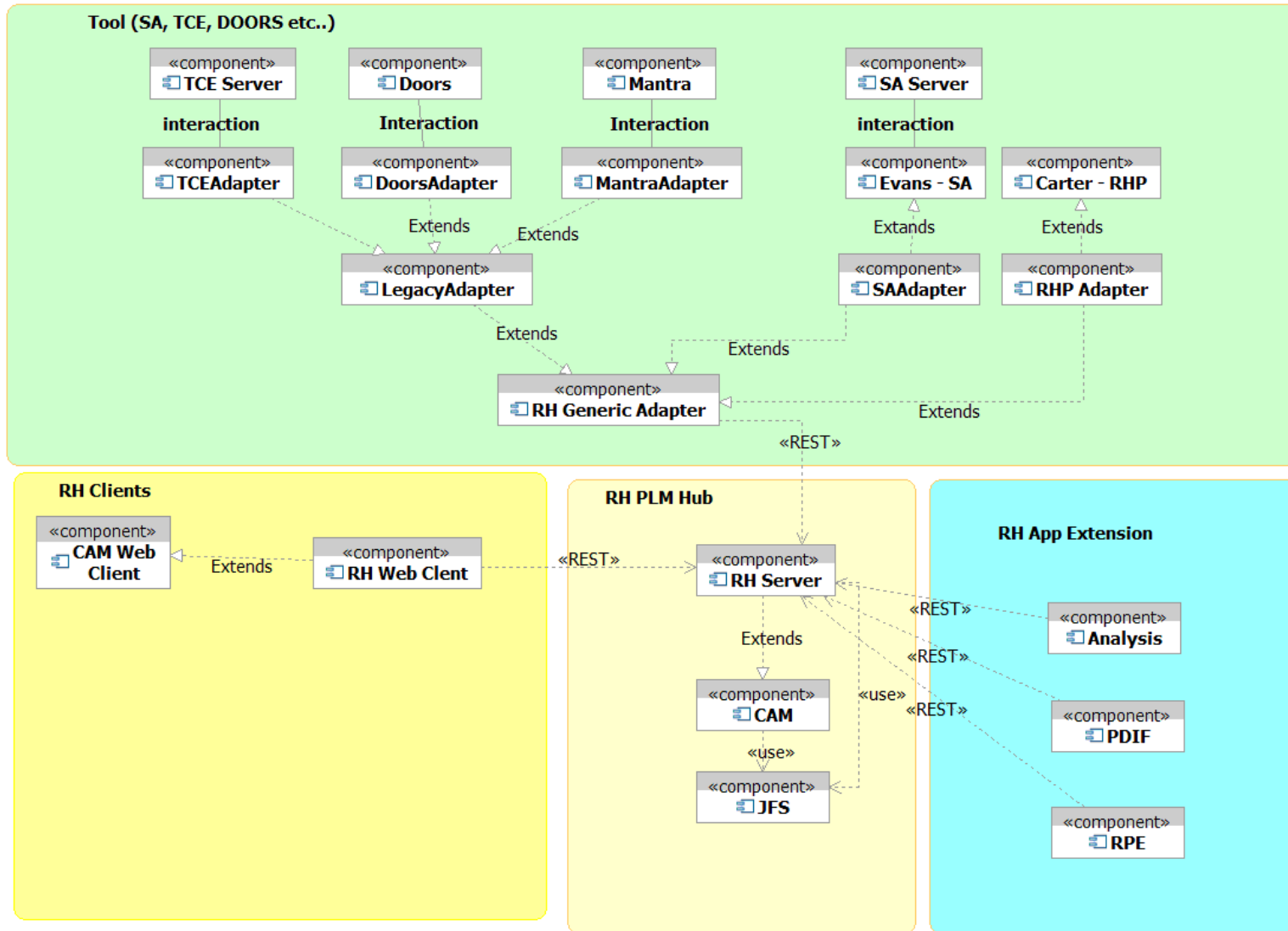

Documents Generation Using RPE - As Is

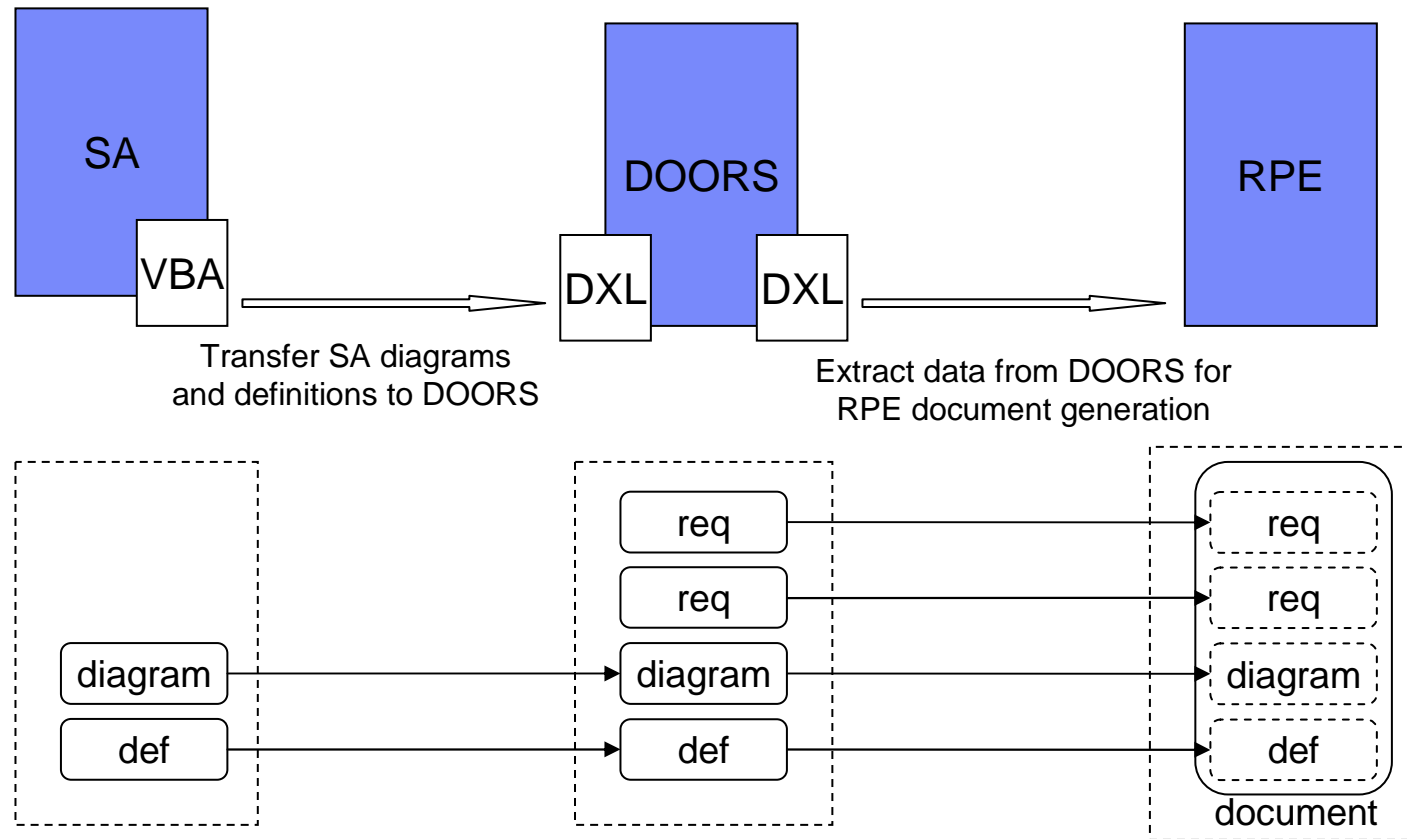

1. Transfer SA diagrams and definitions to DOORS
2. Create links in DOORS
3. Extract data from DOORS for RPE document generation



Documents Generation Using RPE - with Relationship Hub

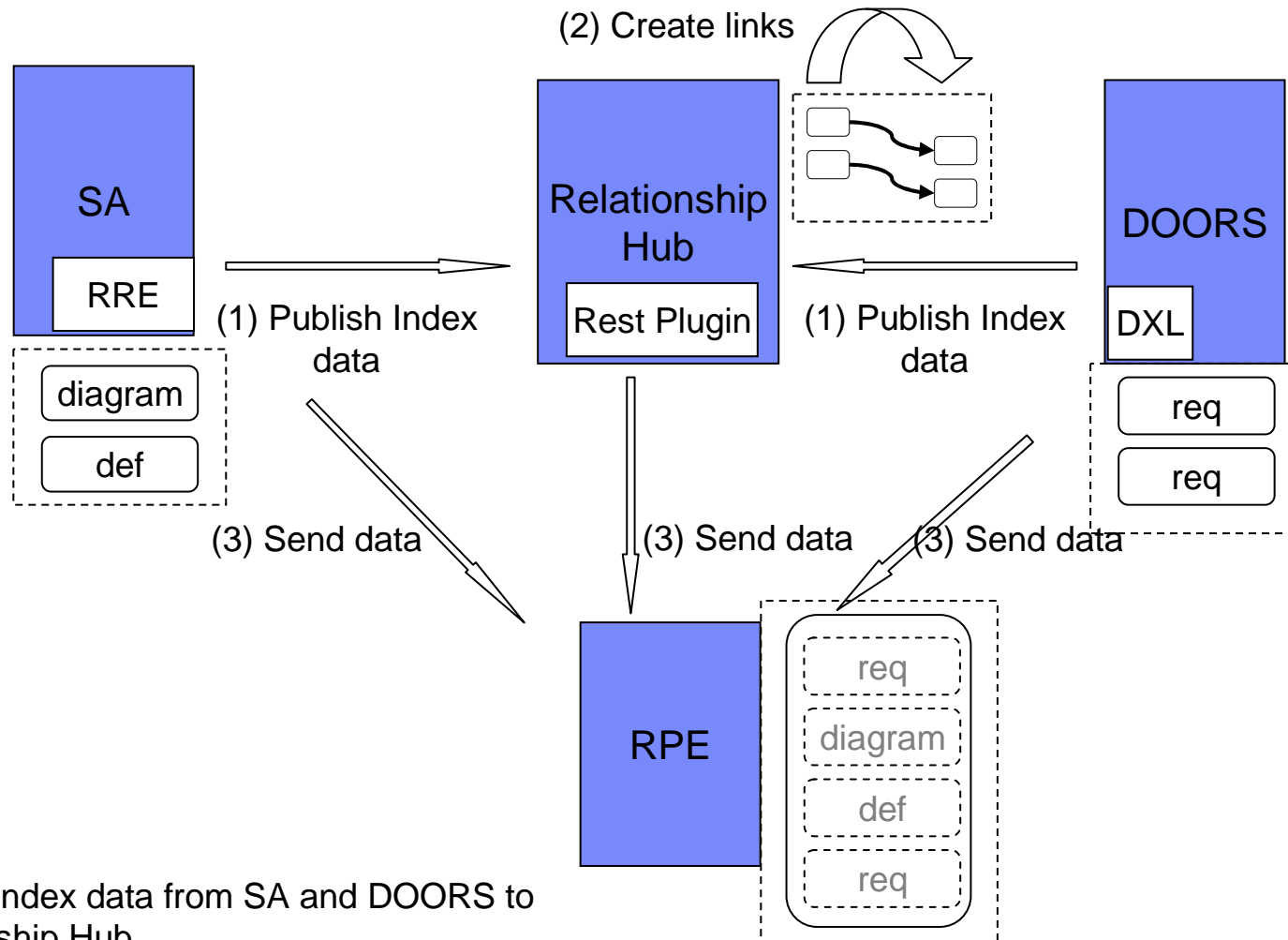

1. Publish Index data from SA and DOORS to Relationship Hub
2. Create links in Relationship Hub
3. Send data from SA/DOORS/Relationship Hub to RPE



Agenda ●

Systems Engineering in IBM

Systems Engineering in Israel Aerospace Industries (IAI)

IBM Research and IAI project collaboration: PLM Relationship Hub (RH)

Demonstration

Summary





Agenda ●

Systems Engineering in IBM

Systems Engineering in Israel Aerospace Industries (IAI)

IBM Research and IAI project collaboration: PLM Relationship Hub (RH)

Demonstration

Summary

Summary

- PLM RH benefits to systems engineering
 - ▶ Harmonizing mechatronic discipline silos into an integrated SE solution
 - Data consistency and navigation across views
 - Overall requirements management & traceability
 - Change management (impact analysis)
 - Project-wide query and reporting
 - Project-wide baselining
- Value to IAI
 - ▶ Better communication between disciplines
 - ▶ Shorter total development time
 - ▶ Rework savings by agile reuse of information across disciplines
- What's next?
 - ▶ Assetize RH as part of the PDIF solution
 - ▶ Leverage the project to drive requirements to the evolution of the Jazz/RELM solution
 - Common baselining, global relationship store, impact analysis
 - Increase reuse of Jazz capabilities in RH asset
 - ▶ Expand the hub to facilitate cross domain PLE, optimization, and simulation



Questions



Daily iPod touch giveaway

- Complete your session surveys online each day at a conference kiosk or on your Innovate 2010 Portal!
- Each day that you complete all of that day's session surveys, your name will be entered to win the daily IPOD touch!
- On Wednesday be sure to complete your full conference evaluation to receive your free conference t-shirt!

SPONSORED BY

AllianceTech
Intelligent EVENTS





www.ibm.com/software/rational

© Copyright IBM Corporation 2010. All rights reserved. The information contained in these materials is provided for informational purposes only, and is provided AS IS without warranty of any kind, express or implied. IBM shall not be responsible for any damages arising out of the use of, or otherwise related to, these materials. Nothing contained in these materials is intended to, nor shall have the effect of, creating any warranties or representations from IBM or its suppliers or licensors, or altering the terms and conditions of the applicable license agreement governing the use of IBM software. References in these materials to IBM products, programs, or services do not imply that they will be available in all countries in which IBM operates. Product release dates and/or capabilities referenced in these materials may change at any time at IBM's sole discretion based on market opportunities or other factors, and are not intended to be a commitment to future product or feature availability in any way. IBM, the IBM logo, Rational, the Rational logo, Telelogic, the Telelogic logo, and other IBM products and services are trademarks of the International Business Machines Corporation, in the United States, other countries or both. Other company, product, or service names may be trademarks or service marks of others.

Let's build a smarter planet.



Open Services for Lifecycle Collaboration

A foundation of the Jazz Integration Architecture

Open Services for Lifecycle Collaboration

Barriers to sharing resources and assets across the software lifecycle

- ▶ Multiple vendors, open source projects, and in-house tools
- ▶ Private vocabularies, formats and stores
- ▶ Inextricable entanglement of tools with their data

- ▶ Specifications for sharing lifecycle resources
- ▶ Inspired by Internet architecture
 - Loosely coupled integration with “just enough” standardization
 - Common resource formats and services
- ▶ A different approach to industry-wide proliferation

